

ELMO

L-12

Document Camera

Teacher's + Choice

ELMO CRA-1 Wireless Tablet
Sold Separately



**A Revolutionary Document Camera—
Engage, Inspire, Make Learning an Adventure!**

L-12 Virtually Limitless Camera Positions

for Every Teaching Situation



300° Swivel

The L-12 can capture images from all directions, thanks to an adjustable camera arm that can be swivelled to broaden the scope of classroom presentations. The solidly constructed camera arm holds its position and is easily operational for both left- and right-handed users.



Full HD
1080p

Adjustable Free-Angle Camera Head & Arm

From above, from the side, up close—explore from any angle! The adjustable camera head and arm can be freely raised, lowered, and rotated to focus attention precisely where it's needed.



Command Attention with Big, Bright, Clear Images

Powerful 96X Zoom

Optical Zoom **12X** × Digital Zoom **8X** = **96X**

When the L-12's high-magnification 12X optical zoom is combined with its 8X digital zoom, images can be enlarged up to 96 times for a clear, distortion-free display of even the tiniest details.

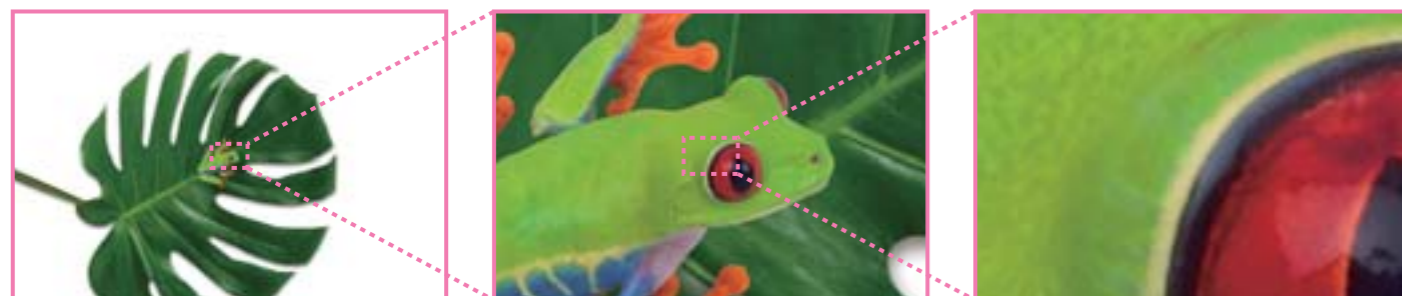

Breathtaking Images Made Easy

3.4-Megapixel CMOS Image Sensor

The L-12's megapixel image sensor captures everything from fine text to three-dimensional objects in 1080p full HD.

Smooth Moving Images at 30 fps

The L-12 captures and reproduces moving images at 30 fps (frames per second) for the display of truly smooth, natural-looking motion.

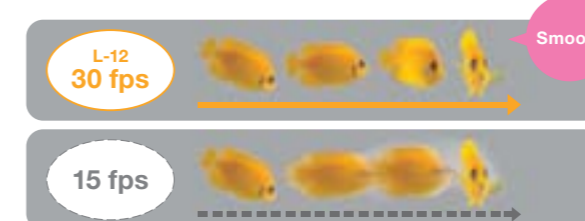

Other Key Features

- Slip-proof rubber feet
- Wireless remote control



Zoom Dial & AF Button

A simple turn of the zoom dial is all that's needed to zoom in and out and make fine zoom adjustments. For added ease of use, the AF (Auto Focus) button enables easy one-touch auto focusing.

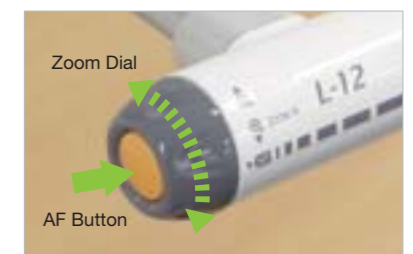

L-12 Virtually Limitless Camera Positions



300° Swivel

The L-12 can capture images from all directions, thanks to an adjustable camera arm that can be swivelled to broaden the scope of classroom presentations. The solidly constructed camera arm holds its position and is easily operational for both left- and right-handed users.



Command Attention with Big, Bright, Clear Images



Powerful 96X Zoom

Optical Zoom **12X** × Digital Zoom **8X** = **96X**

When the L-12's high-magnification 12X optical zoom is combined with its 8X digital zoom, images can be enlarged up to 96 times for a clear, distortion-free display of even the tiniest details.

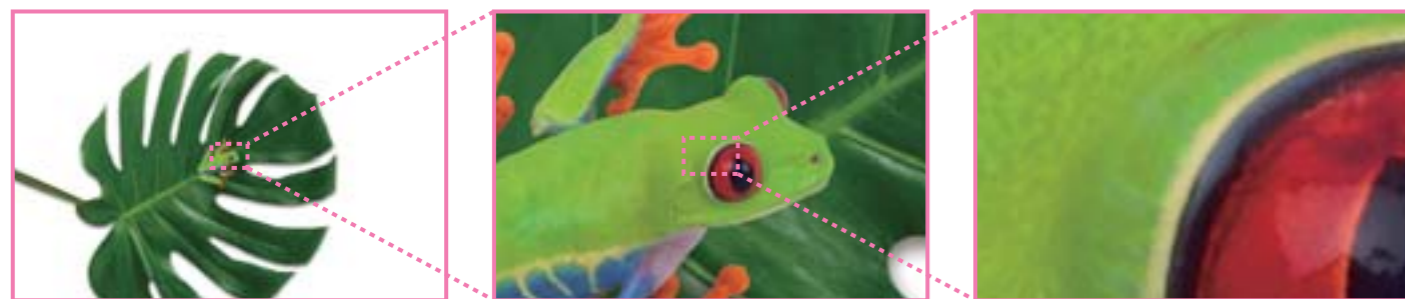

Get Your Point Across Effectively with the L-12 + ELMO Tablet (sold separately)

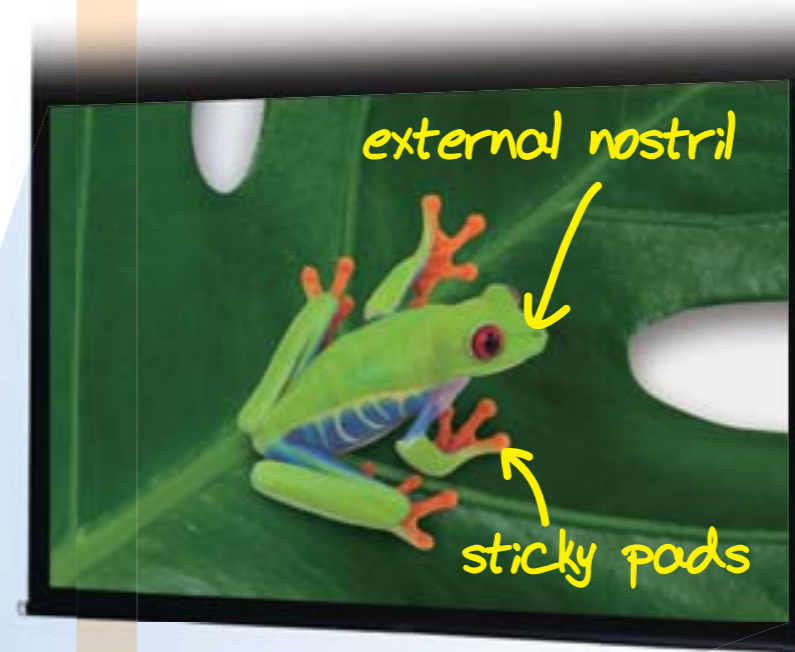

Annotate Live Images

Partner the L-12 with the ELMO CRA-1 Tablet for dynamic smooth-flowing lessons. Teachers can annotate on live images captured by the L-12 while the image is displayed on a large screen. This empowers teachers with the tools to deliver detailed instructions and achieve greater student engagement.

1 Writable Area

The writable area on the ELMO Tablet corresponds to the screen area.

2 Shortcut Keys

Six shortcut keys ensure easy navigation of the ELMO Tablet.

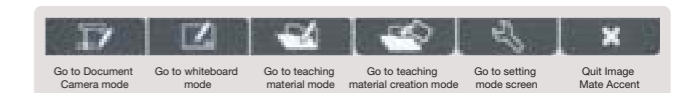

Move Around the Classroom



Wireless Adapter



Because the ELMO Tablet is wireless and can remotely control the L-12, teachers can move freely around the classroom (within 15 metres of the L-12), making it possible to interact with the entire class and individual students.

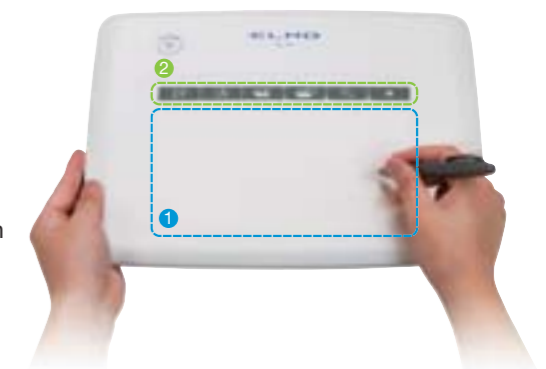

Record Teaching Materials

Video with audio, time-lapse photography, and still images saved on a computer can all be used to create high-impact teaching materials.



Video with audio



Process illustrations



Time-lapse photography

Note: A PC connection is required for intermittent recording and frame recording.

With ...

Use with a PC or Mac
Get added features with Image Mate Accent*
Access a variety of teaching materials
Analyse student progress

* Software supplied with the ELMO Tablet

OR

Without! a Computer

Just plug and play for total ease of use!
Present and annotate without a computer!
Instantly engage students!

Save Full-HD Images with Audio

Selectable Output Resolution

The L-12 offers a variety of output resolutions with a simple flip of a switch!

Resolution
1080p (1920 x 1080)
720p (1280 x 720)
SXGA (1280 x 1024)
WXGA (1280 x 800)
XGA (1024 x 768)
NTSC/PAL

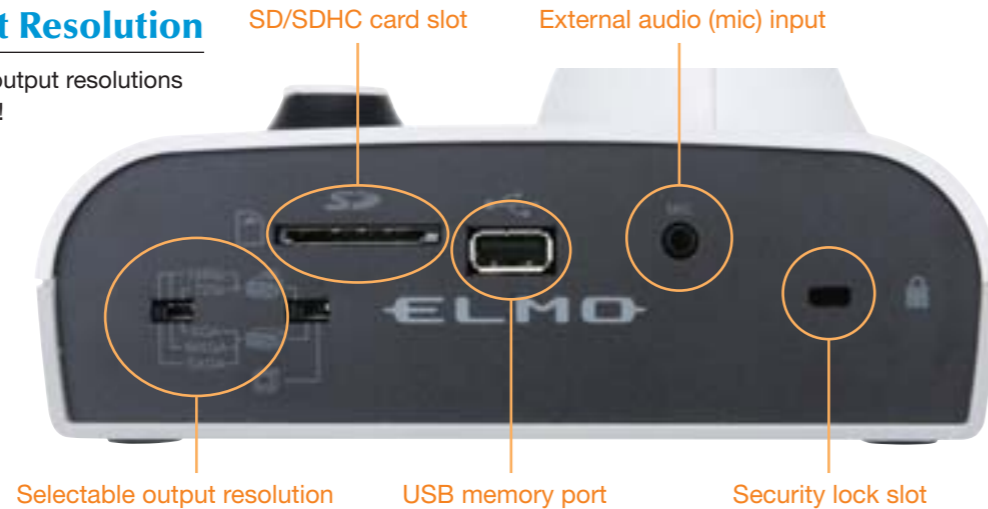

Audio Input & Output

With the L-12 audio enhancement can be added to classroom presentations via the built-in microphone or an external microphone input (Mic In/Line In). Audio output can be routed to the external HDMI or Audio Line Out port.

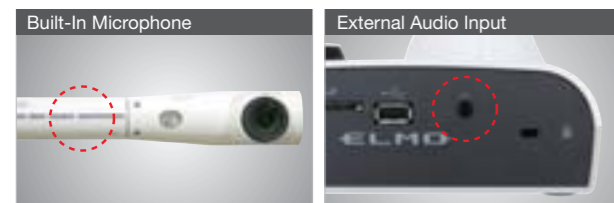

Save Classroom Presentations on External Memory

Both still images (jpg) and audio video files (mp4) can be saved on a USB flash drive or SD Memory Card for future use. Files may also be saved to a PC or Mac using Image Mate Software (included).



Imagine What You Can Do with These Lesson Boosters

Presentation Support Tools

The L-12's ergonomically designed remote control brings convenient functions to classroom presentations.

<p>Split Screen</p> <p>Show a still image and a live image simultaneously.</p>	<p>Highlight</p> <p>Draw attention to a particular section of an image.</p>	<p>Mask</p> <p>Hide a selected part of an image from view.</p>	<p>Mosaic</p> <p>Give images a mosaic-like effect.</p>
<p>Picture-in-Picture</p> <p>Display a quarter-size still image along with a live image.</p>	<p>Colour Filter</p> <p>Blacken specific coloured parts of an image.</p>		

L-12 Specifications

Model	L-12		
Camera	Image pick-up device	1/2.8" CMOS 3,400,000 pixels	
	Total pixels	2,144 (H) x 1,588 (V)	
	Effective pixels	1,920 (H) x 1,536 (V)	
	Frame rate	30 fps	
	Resolution	Analogue RGB: 800 (H) x 800 (V) TV lines or more Video output: 500 (H) TV lines or more	
Optics	Zoom	Powered, 12X optical	
	Lens	F3.2-3.6, f=4.0 mm- 48.0 mm	
	Shooting area	1080p: Max. 420 x 233 mm	Min. 48.5 x 27.5 mm
		720p: Max. 420 x 233 mm	Min. 48.5 x 27.5 mm
		SXGA: Max. 420 x 334 mm	Min. 48.5 x 38.5 mm
		WXGA: Max. 420 x 259 mm	Min. 48.5 x 30.5 mm
XGA: Max. 420 x 313 mm	Min. 48.5 x 36.5 mm		
Focus	Auto / Manual / Zoom Sync		
Functions	White balance	Auto / One-Push / Manual	
	Image mode	Text1 / Text2 / Text3 / Graphics1 / Graphics2	
	Edge enhancement	Provided (only for graphics mode)	
	Pause	Provided	
	Still image storage	Provided	
	Movie storage	Provided	
	Digital zoom	8X	
	Gamma setting	Provided (only for graphics mode)	
	Graphical OSD (on-screen display)	Provided	
	Slide show	Provided (image data)	
	Image save	SD memory card / SDHC memory card / USB flash drive	
	State presetting	Up to 3 user settings	
	Annotation	Provided (on PC screen)	
	Brightness control	Auto (with level adjustment) / Manual	
	Support functions	Highlight, Mask, Scroll (in digital zoom), Mosaic, Split screen, PinP (Picture-in-Picture), Colour filter, Microscope, Image rotation (0°/180°) Positive/negative conversion, Colour/B&W selection	
Interface	Input selection	Main / External	
	Output terminals	RGB output mini D-sub 15-pin connector, female x 1 Composite video output RCA pin jack / 75Ω unbalanced x 1 (NTSC/PAL) HDMI output terminal x 1 Line Out terminal 3.5 mm-diameter stereo mini jack x 1	
	Input terminals	RGB input mini D-sub 15-pin connector, female x 1 Mic In/Line Out terminal (shared), 3.5 mm-diameter stereo mini jack x 1	
	Ext. control terminal	USB device (2.0 compliant) Mini-B receptacle x 1	
	Analogue RGB output	1080p: 1,920 x 1,080 @ 60 Hz	
		720p: 1,280 x 720 @ 60 Hz	
		SXGA: 1,280 x 1,024 @ 60 Hz WXGA: 1,280 x 800 @ 60 Hz XGA: 1,024 x 768 @ 60 Hz	
	HDMI output	Image output: 1080p/720p Audio output: PCM 44.1 kHz sampling frequency	
	Video output selection switch	Provided (NTSC/PAL)	
	Memory interface	SD memory card slot x 1, USB host (2.0 compliant) Type A receptacle x 1	
Lighting	Illumination lamp	White LED	
Others	Accessories	AC adapter, AC cord, RGB cable, USB cable (for connecting to PC)	
		Anti-glare sheet, Remote control, Strap (for remote control), Stage, AAA batteries (for remote control), Dust cover, Image Mate CD-ROM, Image Mate installation manual, Instruction manual (CD-ROM), Basic startup guide, Warranty	
		Security slot	Provided
		Power source	12V DC (AC adapter AC 100-240V)
		Power consumption	17.5 W (AC adapter included)
	Dimensions (W x D x H)	355 x 373.5 x 426.5 mm setup	
		195 x 294 x 469 mm folded	
	Weight	Approx. 3.2 kg (main unit only)	

H: horizontal, V: vertical
Design and specifications are subject to change without prior notice. The images in this brochure are simulated. "ELMO" is a trademark of ELMO COMPANY, LIMITED. SD logo is a trademark. Other brand names and product names may be trademarks or registered trademarks of their respective owners.

ELMO's Helping to Provide a Greener Future for Our Children

This ELMO product complies with RoHS Directive 2002/95/EC (Restriction Of the use of certain Hazardous Substances in electronic equipment). This compliance helps to ensure a healthier and greener environment for all our children.

Profile

All dimensions in mm

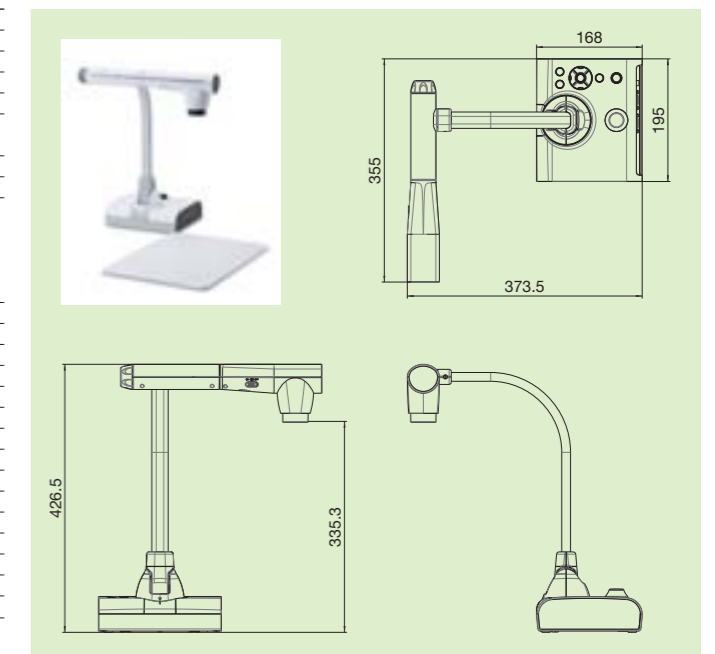

Rear Panel



Option



Microscope Attachment Lens

LET'S Start ICT in Education with "Document Camera"!

Visit the ELMO global website to understand what a document camera is in 13 different languages. The ELMO global website introduces you to the useful and effective ways of using the document camera and how the ELMO document camera is used and supported by teachers worldwide. <http://www.elmoglobal.com>

JCV Japan Committee Vaccines for the World's Children

ELMO CO., LTD. is one of the sponsors for Japan Committee Vaccines for the World's Children (JCV).

JCV operates under basic guidelines and objectives of the Children's Vaccine Initiative (CVI) founded in 1990 by UNICEF, WHO, UNDP, the Rockefeller Foundation, and the World Bank.

ELMO CO., LTD. (Head Office and Factory)'s QMS/EMS has been registered to ISO 9001:2008 and 14001:2004.

ISO 9001 ISO 14001

ELMO CO., LTD.

6-14, Meizen-cho, Mizuho-ku Nagoya, 467-8567, Japan
E-mail : overseassales@elmo.co.jp

London Branch

Crown House, 72 Hammersmith Road, London W14 8TH, U.K.
Tel. 44 (0207) 559-1388
Fax. 44 (0207) 559-1389
E-mail : info@elmo-visualiser.co.uk
Web : <http://www.elmo-visualiser.co.uk>

Taipei Office

11F, Unit #7, No. 171 Songde Road, Xinyi District Taipei City, 110 Taiwan (R.O.C.)
Tel. 886 (0)2 2759 5585
Fax. 886 (0)2 2759 5586

India Office

#3161, 12th Main Service Road HAL 2nd Stage, Indiranagar Bangalore-560 038, India
Tel. 91 (0)8025281994
E-mail : info@elmo.co.in

Distributed by

ELMO Europe SAS

Headquarters
Immeuble Elysées La Défense
7C Place du Dôme
92056 Paris La Défense
France
Tel. 33 (0)1 73 02 67 06
Fax. 33 (0)1 73 02 67 10

German Branch

Hansaallee 201, Haus 1
40549 Düsseldorf
Germany
Tel. 49 (0)211 5447 5640
Fax. 49 (0)211 5447 5660

ELMO (Beijing) Co., Ltd.

Room 1002, 10F, Build. 5, Wanda Plaza
No. 93, Jianguo Road, Chaoyang District
Beijing 100020 P.R. China
Tel. 86 10 5960 3890
Fax. 86 10 5960 3424

ELMO USA Corp.

Headquarters
1478 Old Country Road
Plainview, NY 11803, U.S.A.
Tel. (516) 501-1400
Fax. (516) 501-0429
E-mail : elmo@elmousa.com
Web : <http://www.elmousa.com>

West Coast Branch

5676 Corporate Avenue
Cypress, CA 90630, U.S.A.
Tel. (714) 828-8457
Fax. (714) 828-8429



This brochure is printed on recycled paper with environmentally friendly vegetable oil-based ink.